

A Accessories

Common Accessories

Contact Blocks and LED Blocks for Ø16 Control Switches

Ordering Information



SA	16	CB	W		
Item	Applied switches	Type	LED color ^{※1}	LED block	R Red
					B Blue
					G Green
					Y Yellow
					W White
		CB^{※2}	Contact block	B contact (normally closed)	
		CC	C contact (normally open, normally closed)		
		L5	LED block	5VDC	
		L12		12VDC	
		L24		24VDC	
	16	For Ø16 control switches			
	SA	Switch Accessories			

※1. Only for LED blocks.

※2. Only for Ø16 emergency switches.

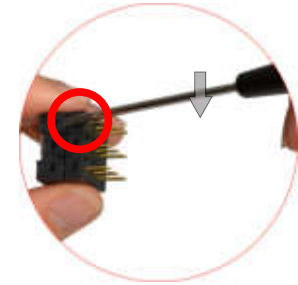
- **Contact block and LED block removal**
Separate the unit using a flat-head (-) screwdriver.



Item	Appearance	Model	Type	Features
Contact block		SA16-CB	B contact (normally closed)	For Ø16 emergency switches
		SA16-CC	C contact (normally open, normally closed)	—
LED block		SA16-L5□ (5VDC) SA16-L12□ (12VDC) SA16-L24□ (24VDC)	DC voltage type	Diverse, vibrant, high luminance LEDs (red, blue, green, yellow, white)

■ Contact Blocks and LED Blocks for Ø22/25, Ø30, □30 Control Switches

○ Ordering Information

SA	—	CA	M	
Item	Applied switches	Type	LED color ^{※1}	Contact block type No-mark Singular type M Modular type
				LED block No-mark White R Red B Blue G Green Y Yellow
Item	Applied switches	Type	LED color ^{※1}	Contact block CA A contact (normally open) CB B contact (normally closed)
				LED block LD AC/DC voltage: 12-24VAC 50/60Hz 12-24VDC LA AC voltage: 110-240VAC 50/60Hz
Item	Applied switches	Type	LED color ^{※1}	For Ø22/25, Ø30, □30 control switches No-mark
				Switch Accessories SA

• **Contact block and LED block removal**
Separate the unit using a flat-head (-) screwdriver.



※1. Only for LED blocks.

※Multi-unit connection is only available for modular type (SA-□M).

Item	Appearance	Model	Type	Features
Modular type contact block		SA-CAM	A contact (normally open)	Ring or spade terminals / Multi-connection (up to 3 units)
		SA-CBM	B contact (normally closed)	
Singular type contact block		SA-CA	A contact (normally open)	Spade terminals only / Loose screw prevention
		SA-CB	B contact (normally closed)	
Modular type LED block		SA-LD□M	AC/DC voltage type 12-24VAC 50/60Hz 12-24VDC	Diverse, vibrant, high luminance LEDs (Red, Blue, Green, Yellow, White)
		SA-LA□M	AC voltage type 110-220VAC 50/60Hz	
Singular type LED block		SA-LD□	AC/DC voltage type 12-24VAC 50/60Hz 12-24VDC	Diverse, vibrant, high luminance LEDs (Red, Blue, Green, Yellow, White)
		SA-LA□	AC voltage type 110-220VAC 50/60Hz	

Control Switches

Ø16

Ø22/25

Ø30

□30

Push Button Switches

Round

Square

Rectangular

Selector Switches

Round

Square

Rectangular

Key Selector Switches

Round

Square

Rectangular

Double Push Button Switches

Mushroom-head Push Button Switches

Emergency Switches

Pilot Lights

Accessories

Buzzers

A Accessories

Switch Enclosures for Ø22/25 Control Switches

Ordering Information

SA		SB	3	
Item	Applied switches	Appearance	Holes	
			1	1 hole
			2	2 holes
			3	3 holes
			4	4 holes
5	5 holes			
Item	Applied switches	SB	Square type	
		TB	Triangle type	
Item	Applied switches	No-mark	For Ø22/25 control switches	
		SA	Switch accessories	



※You can order the other size and the number of holes.

• Hole size: Ø22.5/25.5mm

(unit: mm)

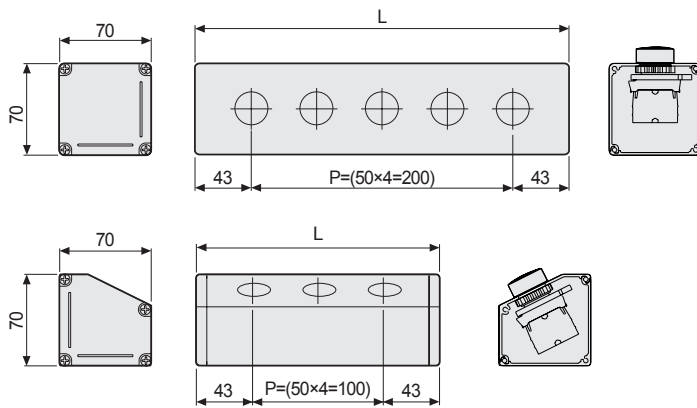

Holes	L
1	86mm
2	136mm
3	186mm
4	236mm
5	286mm













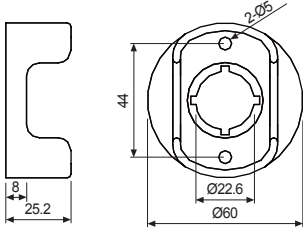

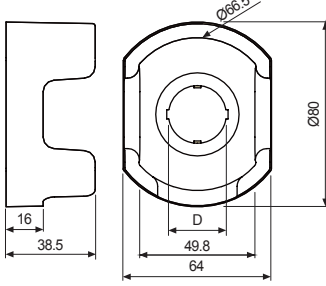
Locking Handle for Switches

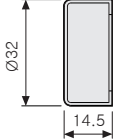
Applied switches	Appearance	Model	Note
Ø16		SA16-LH	For locking switch nuts behind the panels
Ø22/25, Ø30 ^{※1} , □30		SA-LH	

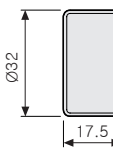
※1. Except Ø30 round pressure switches (extended).

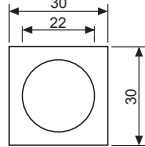
Accessories By Item

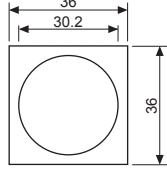
(unit: mm)

Item	Appearance	Model	Dimensions	Note						
Emergency switch nameplates		SA-NS	Size: D60×d25	Standard and illuminated nameplates are available for emergency switches. ※Illuminated nameplates are optional. ※D60 emergency switches (S2ER-E5R□) are not compatible with SA-NS nameplates						
		SA-NL	Size: D80×d25							
Protective shrouds for emergency switches		SA-EG1		Protective shrouds to prevent accidental/incorrect operation <table border="1" style="margin-left: 20px;"><tr><th>D</th><th></th></tr><tr><td>SA-EG2</td><td>Ø22.5</td></tr><tr><td>SA-EG3</td><td>Ø25.5</td></tr></table> ※Not available for D60 emergency switches (S2ER-E5R□).	D		SA-EG2	Ø22.5	SA-EG3	Ø25.5
	D									
SA-EG2	Ø22.5									
SA-EG3	Ø25.5									
		SA-EG2/ SA-EG3								
Waterproof cap for Ø22/25 round push button switches		SA-WP (non-illuminated/ extended)		IP65 protection structure with waterproof cap						
	 (extended)	SA-WL (illuminated/ extended)								
Ø20/25 Switch washer		SA-SW2		The washer helps to improve switch tightening force.						
Ø30 Switch washer		SA-SW3								
Lens remover for Ø16 push button control switches or pilot lights		SA16-RM		Lens remover for push button control switches or pilot lights						

Control Switches

Ø16

Ø22/25

Ø30

□30

Push Button Switches

Round

Square

Rectangular

Selector Switches

Round

Square

Rectangular

Key Selector Switches

Round

Square

Rectangular

Double Push Button Switches

Mushroom-head Push Button Switches

Emergency Switches

Pilot Lights

Accessories

B buzzers